

## CRC35W

Foco de Carril Orientable de 35W

### Producto



Acabados:



### Dimensiones

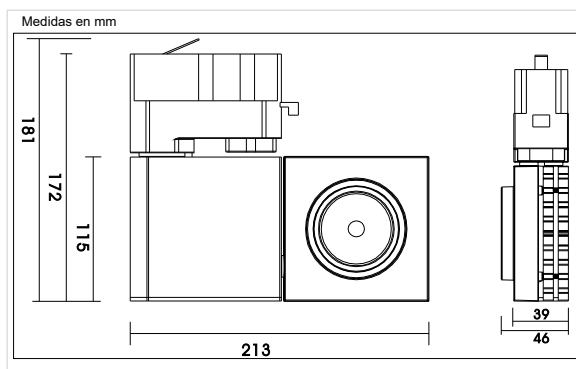

### Datos Técnicos

Entrada:	175~240Vac 50/60Hz
Potencia:	35W
Nº de LEDs:	1 chip COB CREE
Factor Potencia:	>0.95
Eficiencia Lumínica:	101 lm/w
Potencia LED:	35W
Flujo Luminoso:	3524 lm (BF) 3370 lm (BN) 3284 lm (BC)
Intensidad Lumínica:	5980cd
Grado de IP:	IP20
Temp. Trabajo:	-10°C +40°C
Nº Conmutaciones:	30.000
Certificaciones:	CE, RoHS
Eficiencia Energética:	A+
Vida útil:	50.000h (L70:B10)
Peso:	1145 gramos

### Datos Fotométricos

**Ángulo de apertura** =24°, 38°, 60°  
**Flujo Luminoso** =3524 lm  
**Tª de color CCT** =5000K (BF)  
**CRI** =>80

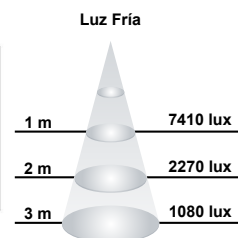
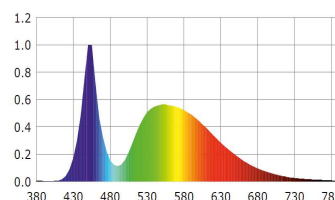

**Ángulo de apertura** =24°, 38°, 60°  
**Flujo Luminoso** =3370 lm  
**Tª de color CCT** =4000K (BN)  
**CRI** =>80

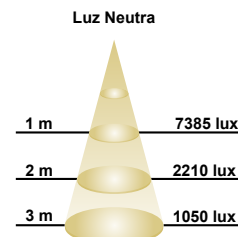
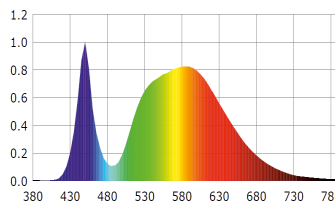

**Ángulo de apertura** =24°, 38°, 60°  
**Flujo Luminoso** =3284 lm  
**Tª de color CCT** =3000K (BC)  
**CRI** =>80

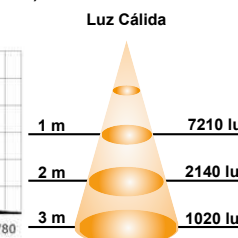
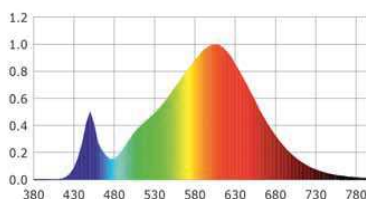

Curva de Distribución Lumínica

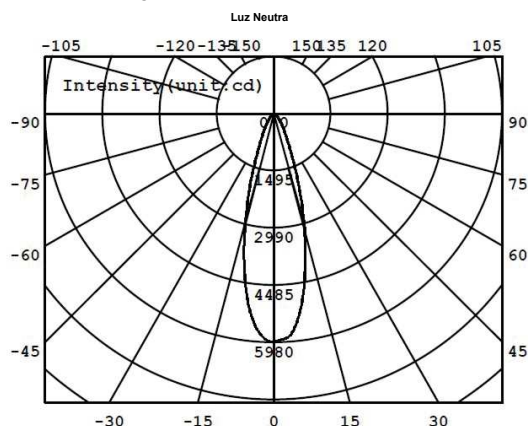

Chip utilizado

